

stainless steel (hill)slides

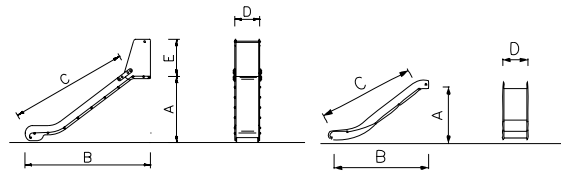

overview stainless steel slides

Nr	A	B	C	D	E
G512	137	260	244	50	75
G112	137	260	244	100	75
G521	202	346	350	50	75
G121	202	346	350	100	75
G526	262	426	449	50	75
G126	262	426	449	100	75
G490	90	159	152	40	

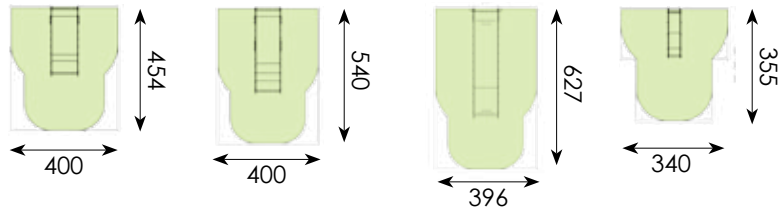

(G112 19 m²) (G121 22 m²) (G126 25 m²) (G490 10 m²)

Materials:

- sheet material in polyethylene
- stainless-steel slide plate thickness 1.5 mm
- security bar polyester coated

plastic slide

REF. G300 (platform height ± 1,3 m)

REF. G305 (platform height ± 0,85 m)

REF. G001 (fill wall for G300, for wooden structures)

REF. G301 (slide G300 + fill wall for wooden structures)

REF. G302 (slide G300 + fill wall for S421)

REF. M070 (slide G300 + fill wall for metal equipment)

REF. M072 (slide G305 + fill wall for metal equipment)

Material: polyethylene

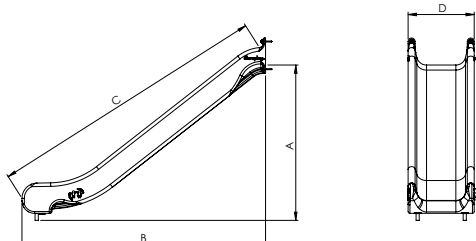
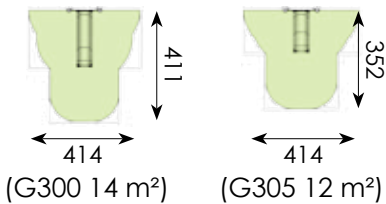

colourful slide

REF. G375 (short slide)

REF. G480 (long slide)

REF. M071 (colorful slide + fill wall for metal equipment)

Material: polyethylene

Comes in loose parts



M071



G480

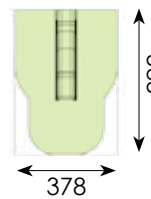
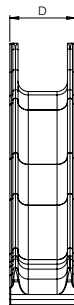
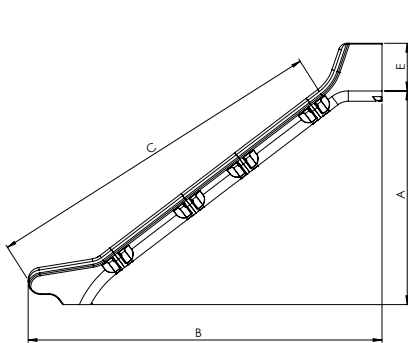

(G375 21 m²)

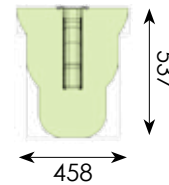

(G480/M071 22 m²)

spiral slide



REF. G400 (spiral slide)

REF. G002 (metal connection handrails for G400 for wooden structures)

REF. L791 (custom floor for G400 for wooden structures)

REF. G003 (metal connection handrails for G400 for metal structures)

REF. L793 (custom floor for G400 for metal structures)

Material:

- polyethylene
- handrails in polyester coated tube (REF. G003)

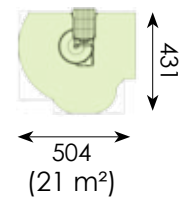
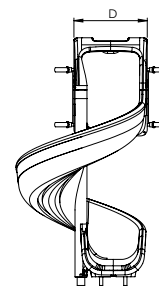
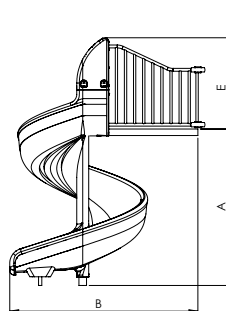

(21 m²)

overview plastic slides

Nr	A	B	C	D	E
G300	132	210	244	56	-
G305	84	152	169	56	-
G375	183	335	375	78	58
G480	258	420	480	78	58
G400	183	220	-	83	107